

**BRB50N06**  
Rev.E Jan.-2019

TO-263          N          MOS          N-CHANNEL MOSFET in a TO-263 Plastic Package.

$R_{DS(on)}$           C1



Electrical Characteristic Curve

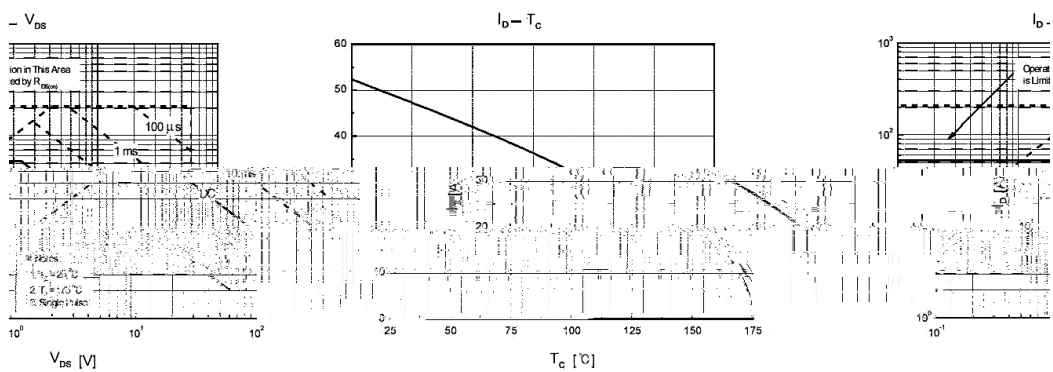
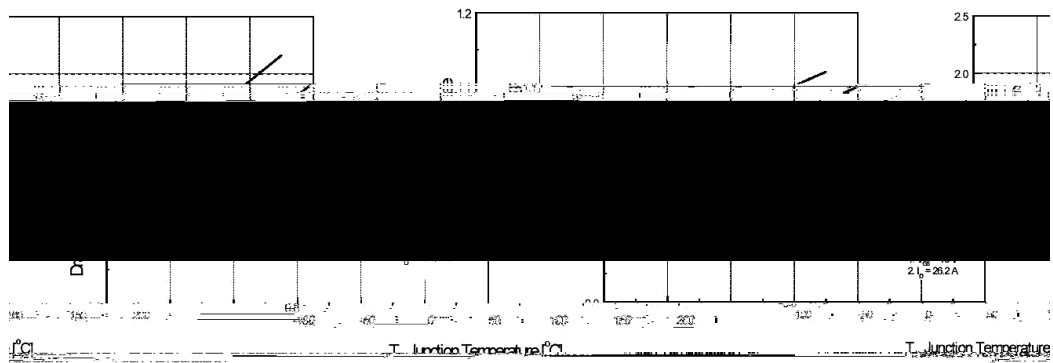
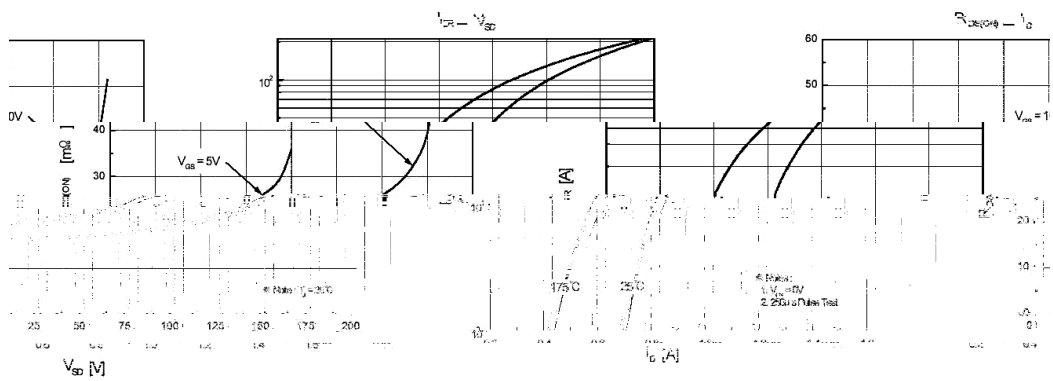
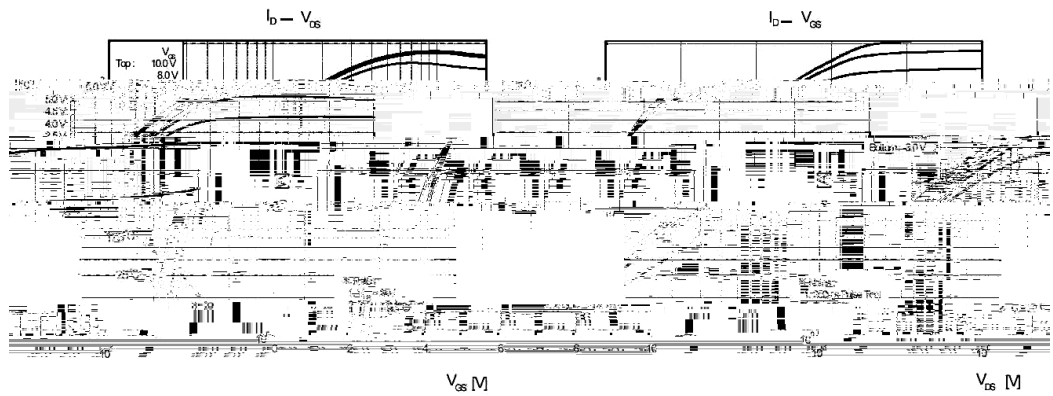

∅ □ = ) ∅ / Package Dimensions

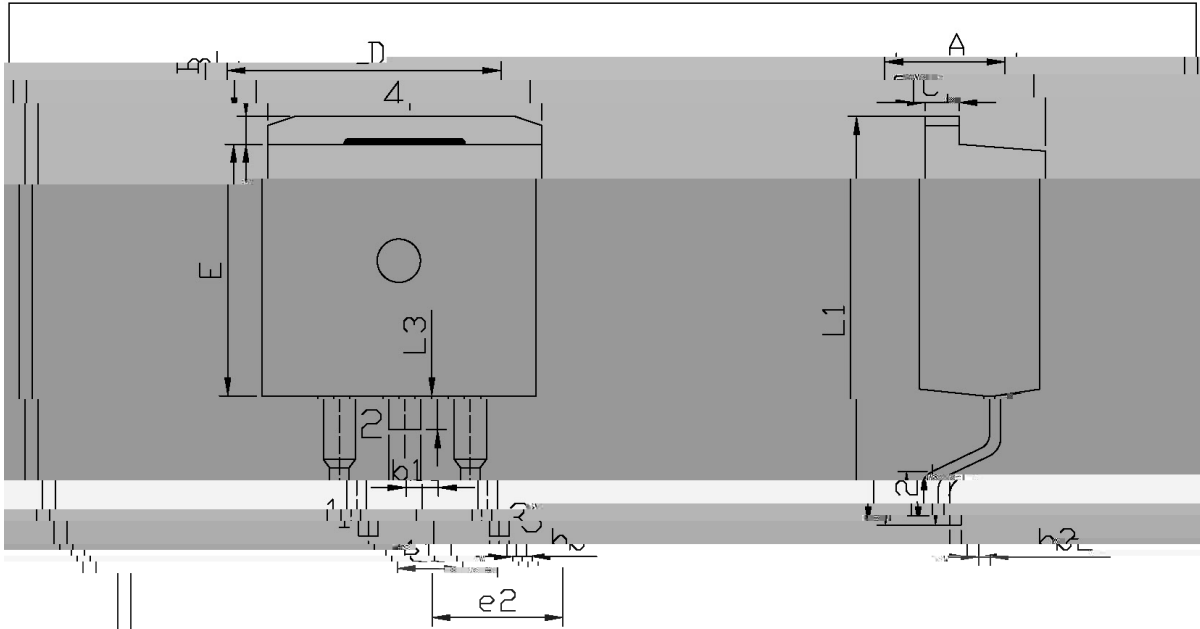

单位: mm

Dimensions in Millimeters

Max	Min	Max	Min
9.40	4.30	4.70	9.00
2.74	1.00	1.40	2.24

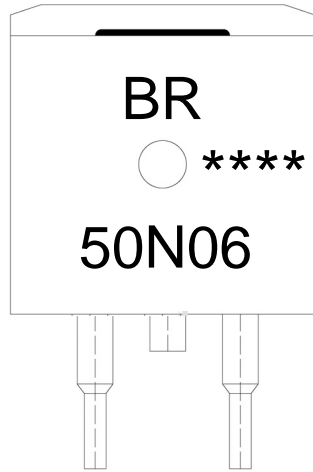

šWD t... •Žϕ (x/ ) / :KSVKXGZ[XK 6XULORK LUX /8 8KLRU] 9URJKXOTM 6

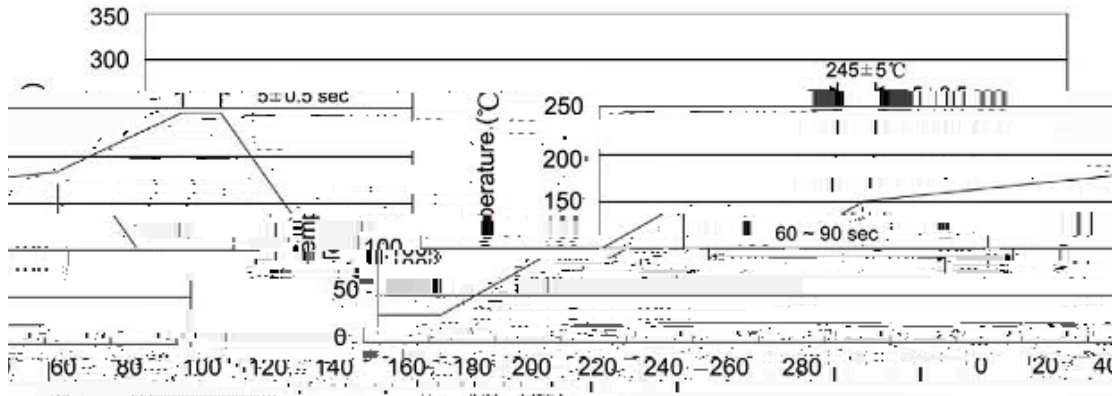

Note:

1            150   180            60