

SOT23-3

Low dropout linear regulator in a SOT23-3 Plastic Package.

20V

 1.5 μ A

 $\pm 2\%$

 Low power consumption,Low voltage drop,Small temperature drift coefficient,High input voltage up to 20V,The static current 1.5 μ A,The output voltage accuracy: $\pm 2\%$,HF Product.

For use in power equipment,Communication equipment,Audio and video equipment.

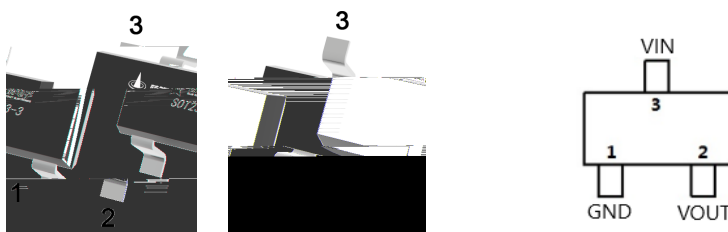
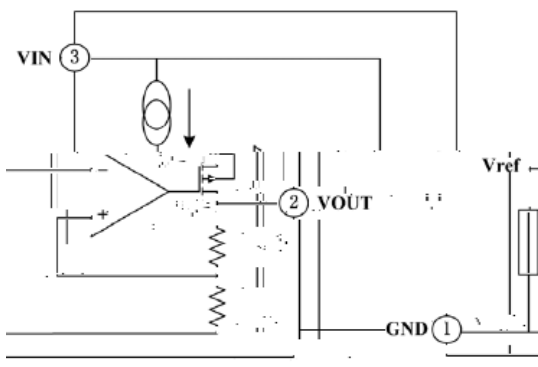

1	GND		3	VIN	
2	VOUT				

/ See Marking Instructions.

Parameter	Symbol	Rating	Unit
Working Voltage	V_{IN}	-0.3~+20	V
Thermal Resistance	R_{JA}	200	/W
Power Consumption	P_D	500	mW
Storage Temperature	T_{STG}	-50~+125	
Working Temperature	T_A	-40~+85	

Notes: If the device operating condi

/ Circuit for Increasing Output Voltage

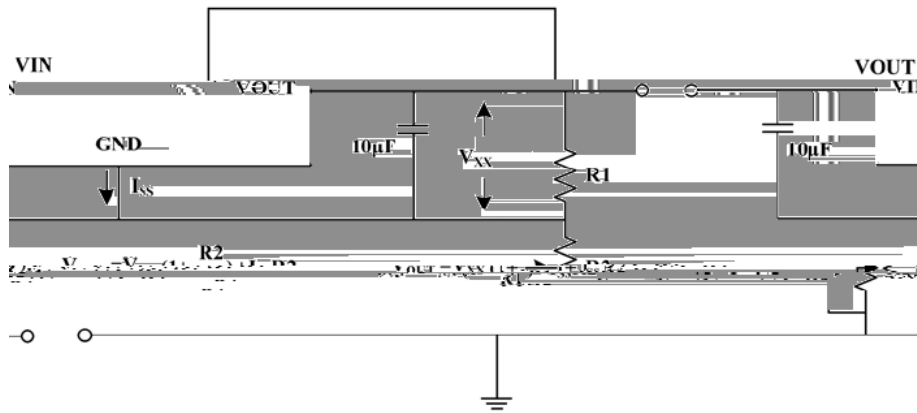

/ Constant Current Regulator

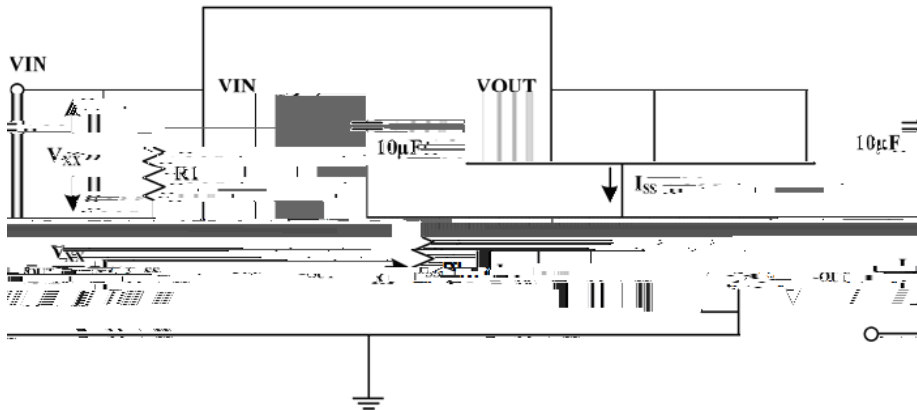

/ Double Output Circuit

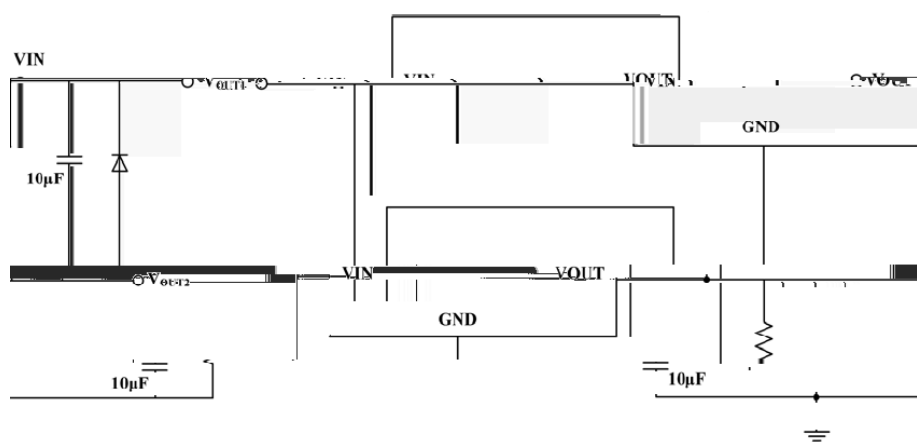

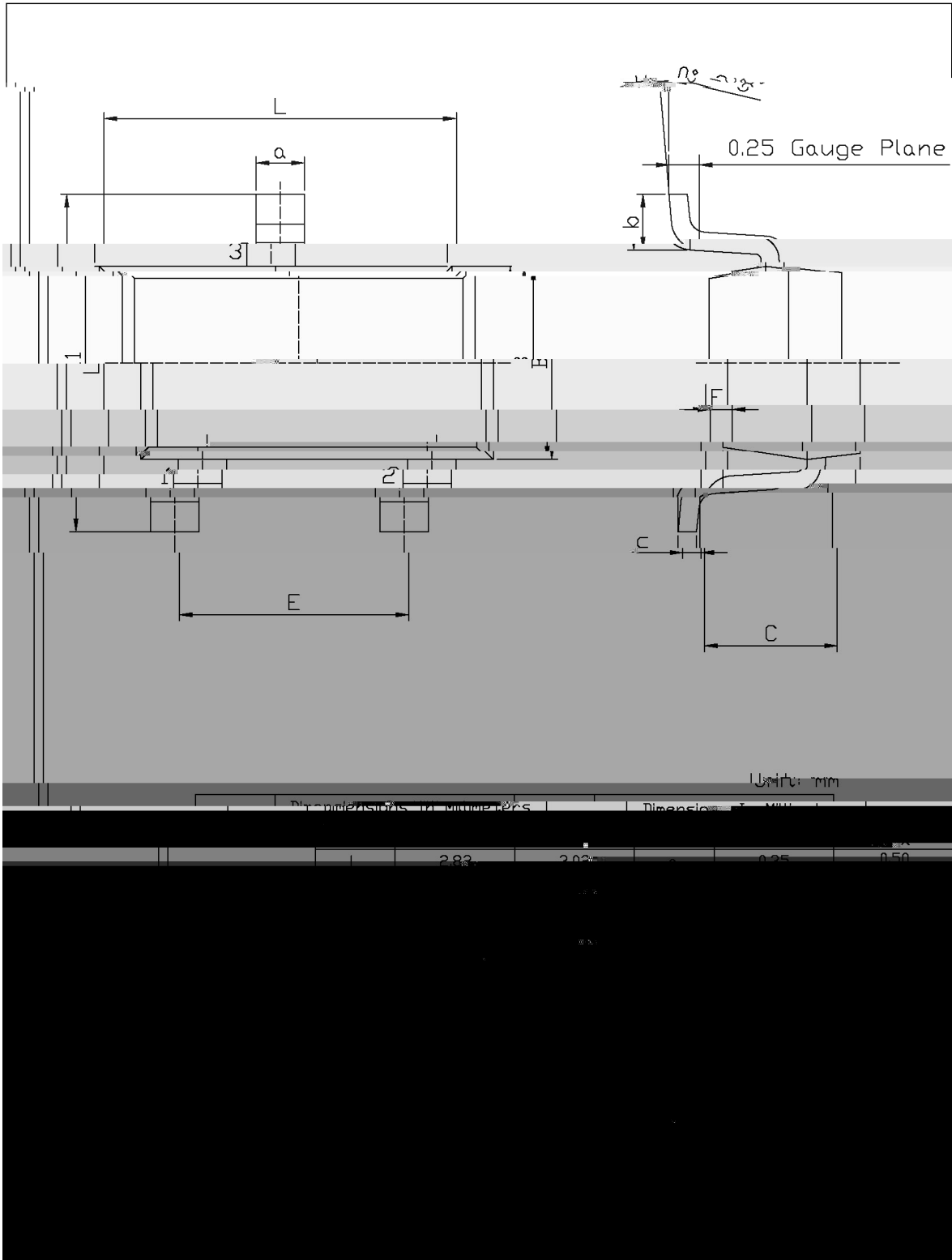

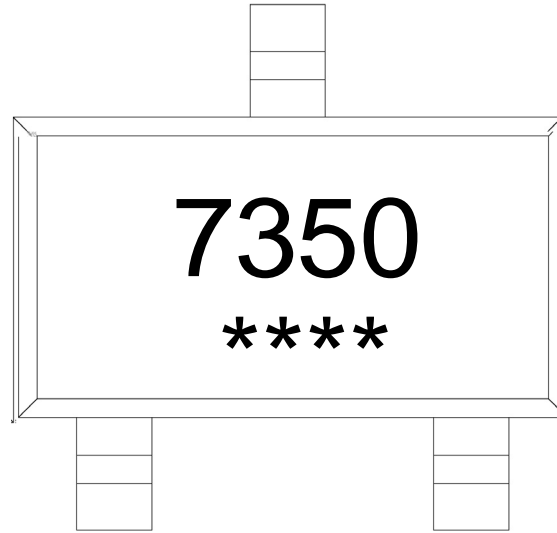

7350

Note:

7350: Product Type

****: Lot No. Code, code change with Lot No

